

3W or 5W Emitter on
Miniature MCPCB Option
LZ1-3xxx0x

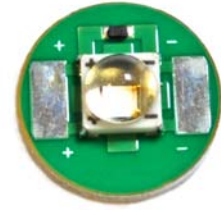



















Key Features

- 11.5mm diameter Miniature MCPCB
- Typical Thermal Resistance for MCPCB adds only 2°C/W
- MCPCB contains Zener Diode for enhanced ESD protection

Available Products

Table 1:

Colors	3W Part Number	Emitter Link	5W Part Number	Emitter Link
Red	LZ1-30R103		LZ1-30R105	
Deep Red	LZ1-30R203		LZ1-30R205	
Green	LZ1-30G103		LZ1-30G105	
Blue	LZ1-30B203		LZ1-30B205	
Amber	LZ1-30A103		LZ1-30A105	
Cool White	LZ1-30CW03		LZ1-30CW05	
Neutral White	LZ1-30NW03		LZ1-30NW05	
Warm White	LZ1-30WW03		LZ1-30WW05	
Dental Blue	n/a		LZ1-30DB05	
UV	n/a		LZ1-30UA05	

[Click on Emitter Link for emitter data sheet.](#)

Description

The LZ1-3xxx0x Miniature MCPCB option provides a convenient method to mount LedEngin's 3W or 5W emitters in many portable applications including dental wands. The MCPCB contains a Zener diode for enhanced ESD protection.

R_{θJ-B} Lookup Table

Table 2:

Product	Typical Emitter R _{θJ-C}	+	Typical MCPCB R _{θC-B}	=	Typical Emitter + MCPCB R _{θJ-B} ^[1]
3W	11°C/W	+	2°C/W	=	13°C/W
5W	5.5°C/W	+	2°C/W	=	7.5°C/W

Note for Table 2:

- R_{θJ-B} is the combined thermal resistance from the LED die junction to the Aluminum core on MCPCB (R_{θJ-C} + R_{θC-B} = R_{θJ-B}).

Emitter on Miniature MCPCB Dimensions (mm)

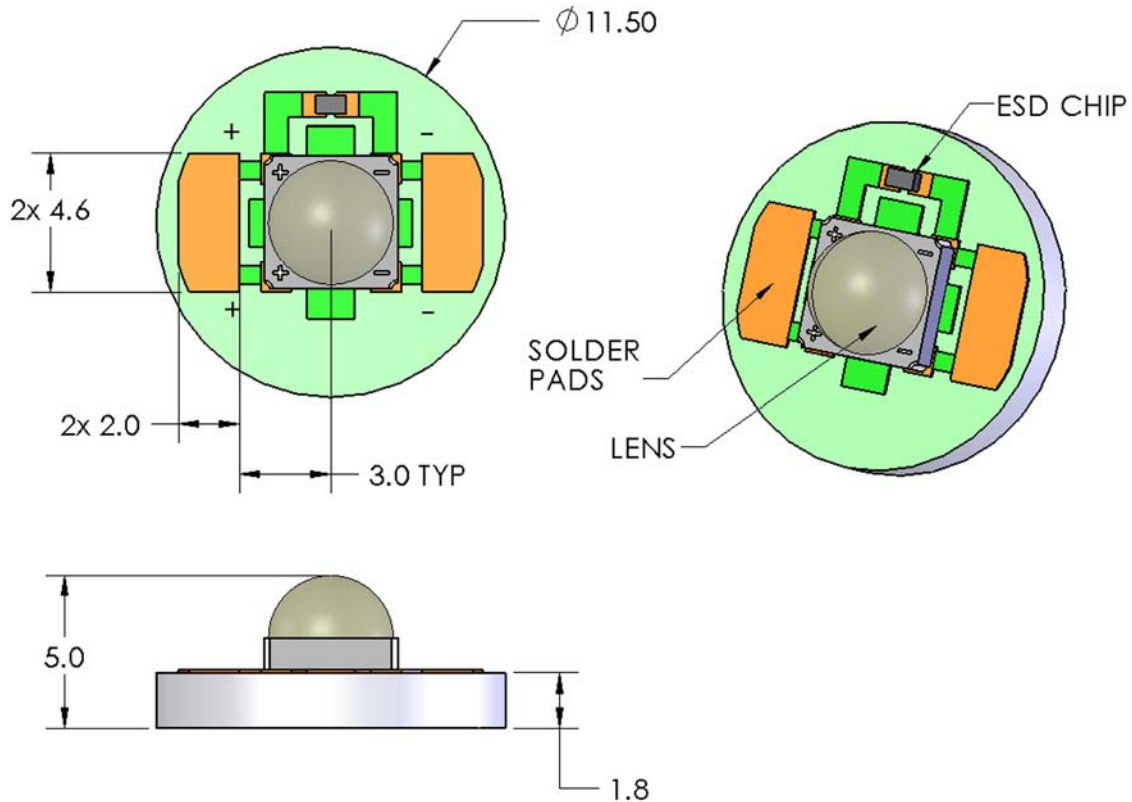

Figure 1: Miniature MCPCB outline dimensions (mm).

Note for Figure 1:

- Unless otherwise noted, the tolerance = ± 0.20 mm.
- Electrical connection pads on MCPCB are labeled "+" for Anode and "-" for Cathode.
- LedEngin recommends using thermally conductive tape or adhesives when attaching MCPCB to a heat sink.

Company Information

The LZ1-3xxx0x LED emitter on MCPCB is developed, manufactured, and marketed by LedEngin, Inc., located in Santa Clara, CA. LedEngin is a global leader in advanced high-power LED emitters and light-source modules. LedEngin provides total solutions from 3W to 15W in single packages with ultra-small footprints in all colors from Cool White, Warm White, Neutral White, Red, Green Blue, Amber, RGB, RGBA, Dental Blue and UV. LedEngin supports customers to generate solid-state lighting designs that conserve natural resources. LedEngin is focused on differentiated Ultra High-Brightness LED solutions for diverse global markets using its patent-pending package designs and manufacturing processes. LedEngin offers catalog as well as full custom solutions to enable flexible system designs for its customers. LedEngin is dedicated to long-term win-win partnering with its customers and suppliers.

LedEngin reserves the right to make changes to improve performance without notice.

Please contact Sales@ledengin.com or (408) 492-0620 for more information.